

House	44.73981 Osten A 44 ISO	Sheet	1
Drawing	3D	Scale	
Material	44X135	Date	14.12.2023
Drawer	RP	File	44.73981 Osten A 44 ISO 3D.dwg

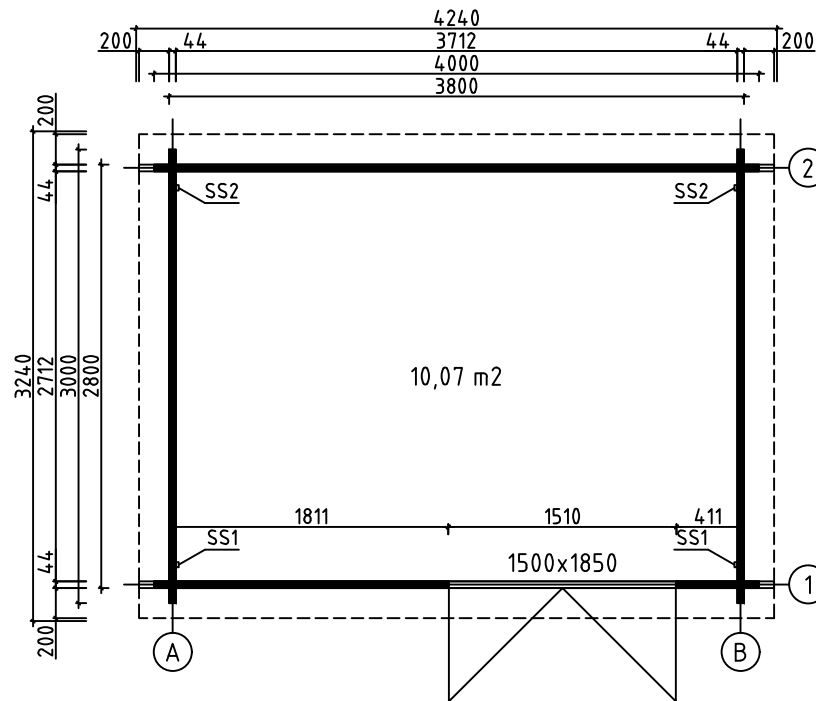

House	4473981 Osten A 44 ISO	Sheet	2
Drawing	GROUNDPLAN-GRUNDPLAN-PLAN	Scale	1:50
Material	44x135	Date	14.12.2023
Drawer	RP	File	4473981 Osten A 44 ISO.dwg

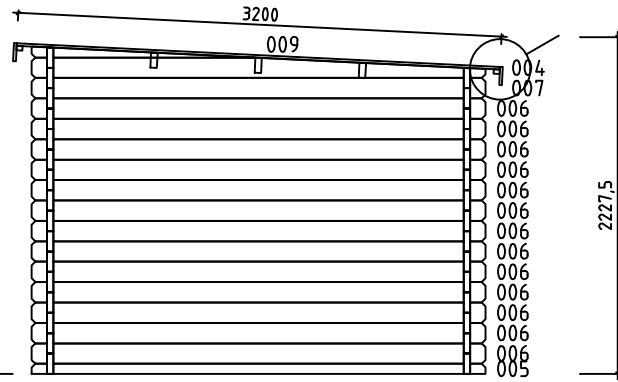
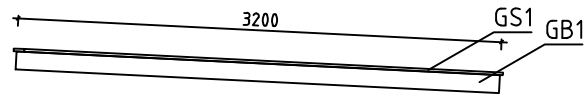
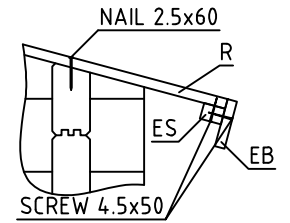

Wall-Wand-Muur A

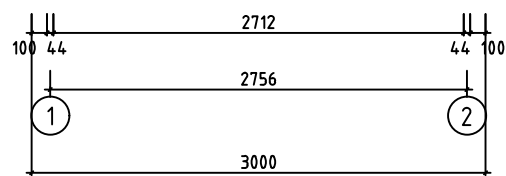

House	4473981 Osten A 44 ISO	Sheet	3
Drawing	WALL-WAND-MUUR A	Scale	1:50
Material	44x135	Date	14.12.2023
Drawer	RP	File	4473981 Osten A 44 ISO.dwg

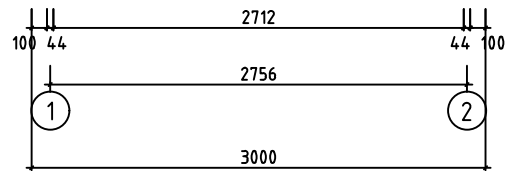
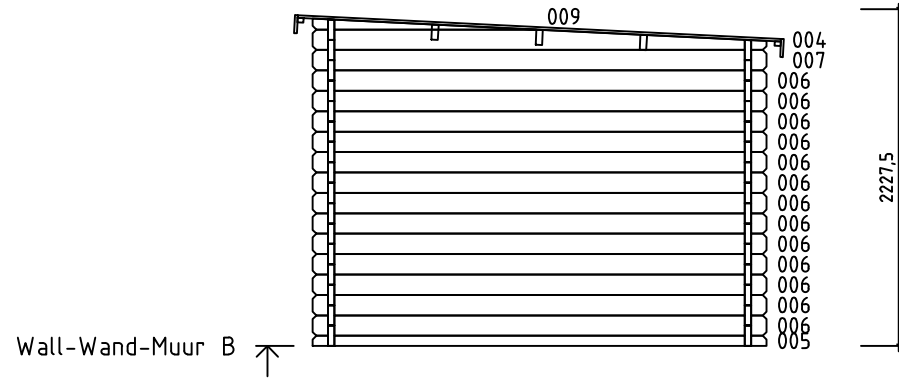
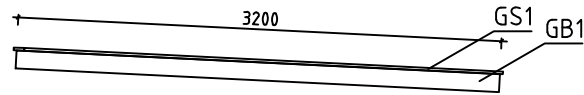



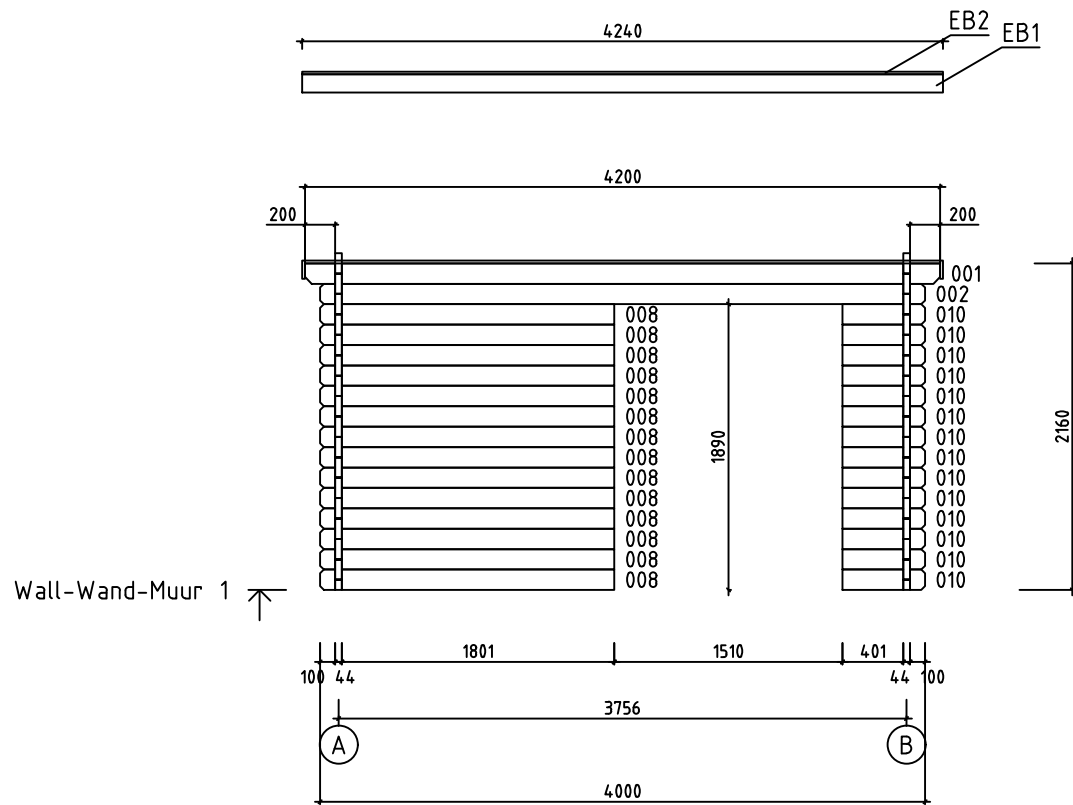



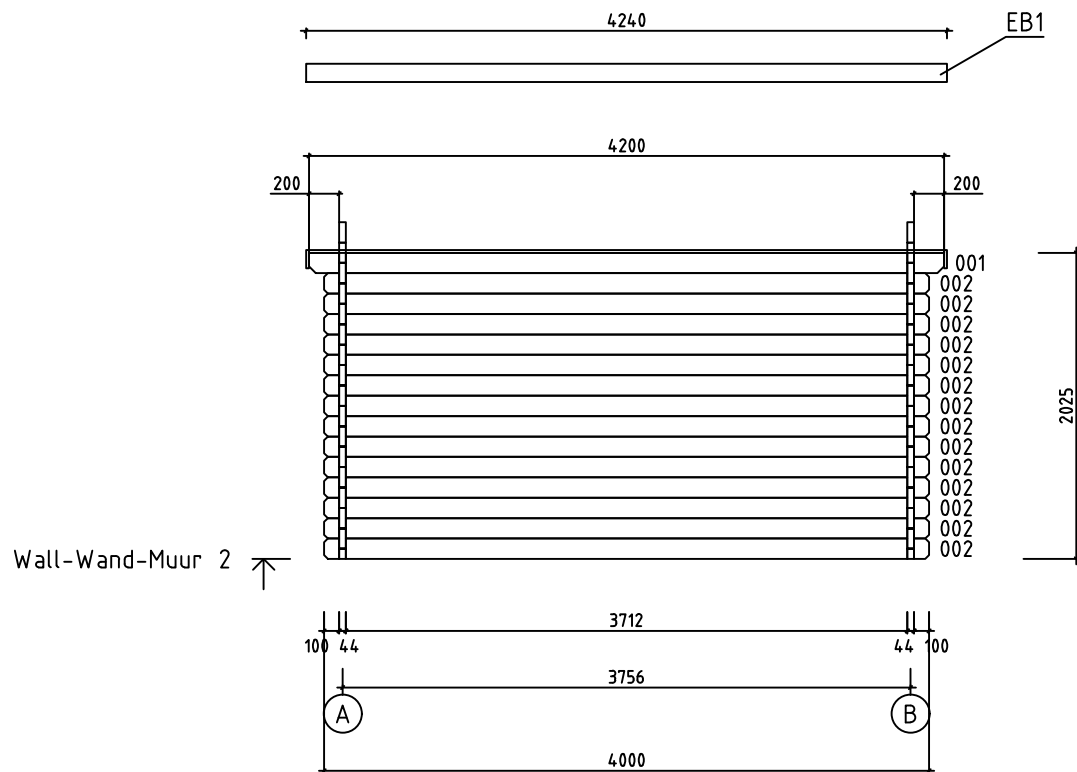



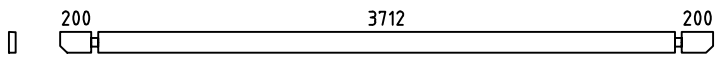
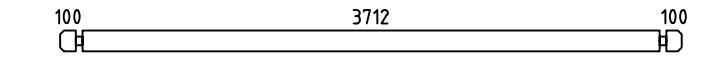
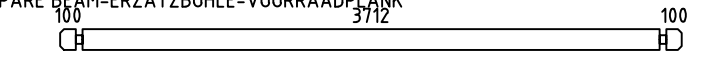
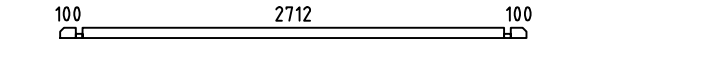
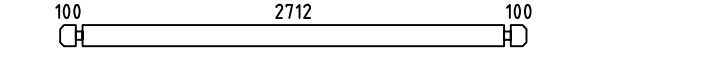
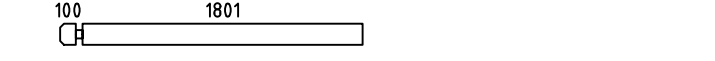

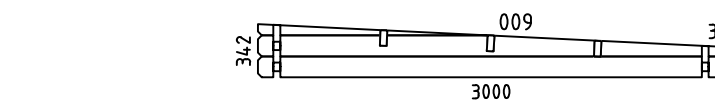

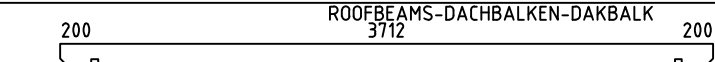



House	4473981 Osten A 44 ISO	Sheet	4
Drawing	WALL-WAND-MUUR B	Scale	1:50
Material	44x135	Date	14.12.2023
Drawer	RP	File	4473981 Osten A 44 ISO.dwg



House	4473981 Osten A 44 ISO	Sheet	5
Drawing	WALL-WAND-MUUR 1	Scale	1:50
Material	44x135	Date	14.12.2023
Drawer	RP	File	4473981 Osten A 44 ISO.dwg



House	4473981 Osten A 44 ISO	Sheet	6
Drawing	WALL-WAND-MUUR 2	Scale	1:50
Material	44x135	Date	14.12.2023
Drawer	RP	File	4473981 Osten A 44 ISO.dwg

Pos	Specification-Bestimmung-Omschrijving	Pcs	Profile (mm)	L (mm)		
001		2	44x135	4200		
002		15	44x135	4000		
003	SPARE BEAM-ERZATZBOHLE-VOORRAADPLANK 	1	44x135	4000		
005		2	44x68	3000		
006		26	44x135	3000		
008		14	44x135	1945		
010		14	44x135	545		
WA-1 WB-1		2	44x342	3000		
HB	HIT BLOCK-SCHLAGHÖLZER-BLAZENPLANK 	2	44x135	300		
RB1	ROOFBEAMS-DACHBALKEN-DAKBALK 	3	43x140	4200		
R1	ROOFBOARD-DACHBRETT-DAKPLANK  or-oder-of	37+1 48+1	18x114 18x88	3200		
GB1	GABLE BOARD-GIEBELBLENDE-GEVELPLANK 	2	18x120	3200		
GS1	ROOF FELT FILLET-GIEBELLEISTE-GEVELLIJST 	2	18x70	3170		
EB1	EAVE BOARD-TRAUFBRETT-AFDEKPLANK 	2	18x120	4240		
EB2	EAVE BOARD-TRAUFBRETT-AFDEKPLANK 	1	18x70	4240		
ES1	EAVE SLAT-TRAUFENLEISTE-AFDEKLIJST 	2	30x40	4200		
SS1	STORM SLAT-STURMLEISTE-STORMLIJST 	2	18x35	2030		
SS2	STORM SLAT-STURMLEISTE-STORMLIJST 	2	18x35	1930		
	SCREWS-SCHRAUBEN-SCHROEF FOR-FÜR-VOOR SS1, SS2 	12	ø6.0	50		
	WASHER-SCHEIBE-SCHIJF FOR-FÜR-VOOR SS1, SS2 	12	ø6.0	18		
	NAIL-NAGEL-NAGEL FOR-FÜR-VOOR R1 	250	ø2.5	60		
	SCREWS-SCHRAUBEN-SCHROEF FOR-FÜR-VOOR GB1, GS1, EB1, ES1 	60	ø4.5	50		
	SCREWS-SCHRAUBEN-SCHROEF FOR-FÜR-VOOR RB1 	6	ø6.0	160		
House	4473981 Osten A 44 ISO	Material	File	4473981 Osten A 44 ISO.dwg	Sheet	7

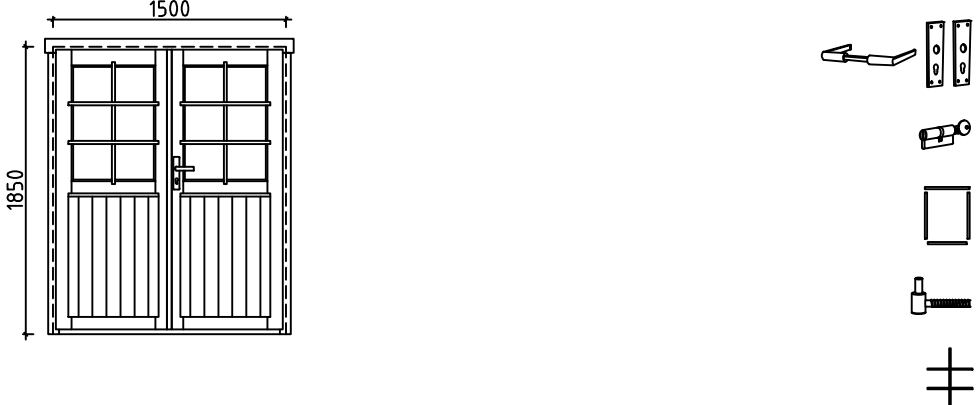
Pos	Specification-Bestimmung-Omschrijving	Pcs	Profile (mm)	L (mm)
	<p data-bbox="263 145 1257 179">DOUBLED00R-DOPPELTÜR-DUBBELE DEUR (right-rechts-rechts) AST_ISO_PL P</p> 	<p data-bbox="1292 145 1316 174">1</p> <p data-bbox="1292 224 1316 253">1</p> <p data-bbox="1292 302 1316 331">1</p> <p data-bbox="1292 380 1316 409">1</p> <p data-bbox="1292 459 1316 488">6</p> <p data-bbox="1292 537 1316 566">2</p>	<p data-bbox="1364 145 1428 174">1500</p>	<p data-bbox="1476 145 1540 174">1850</p>

#001	1,2	4200	2
#002	1,2	4000	15
#003		4000	1
#004	A,B	3000	2
#005	A,B	3000	2
#006	A,B	3000	26
#007	A,B	3000	2
#008	1	1945	14
#009	A,B	1478	2
#010	1	545	14